

• VSR 500

SLIDING GATE MOTOR (VSR SERIES)

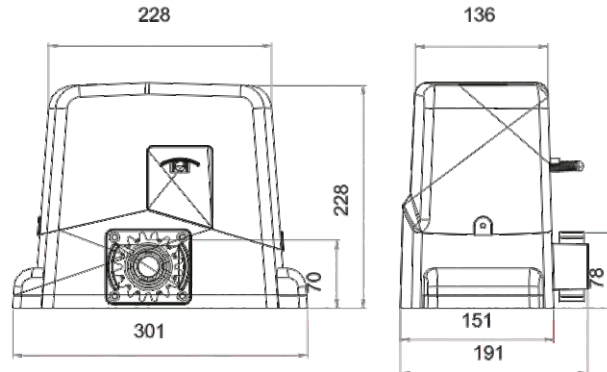
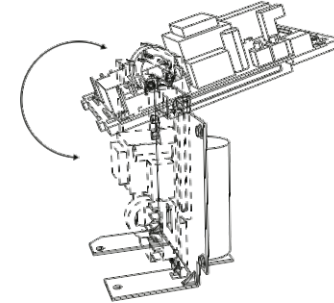

Item No.	VSR 500
Power Supply	AC220V/AC110V
Torque	20N.M
Motor Speed	1440RPM
Gate Speed	10m/min
Max. Gate Weight	500Kg
Noise	≤56dB
Limited Switch Option	Spring Limit Switch
Thermal Protection Temperature	135°C
Working Cycle	25%
Working Temperature	-45°C~+65°C
IP Class	IP44